

Installation Instructions

Undermount Single Bowl Sinks

- LXZS881R
- LXZS771R
- LXZS882R
- LXZS772R
- LXZS773R
- LXZS883R
- LXZS884R
- LXZS774R

Undermount Double Bowl Sinks

- LXZD881R
- LXZD771R
- LXZD881LDR
- LXZD771LDR
- LXZD882R
- LXZD772R
- LXZD882LDR
- LXZD772LDR

Tools You Will Need

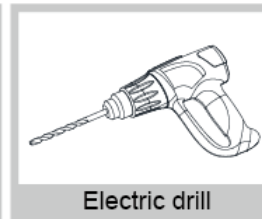
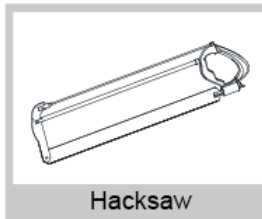
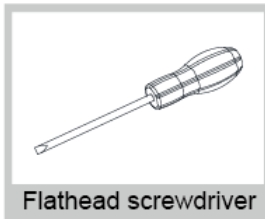
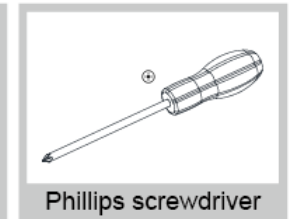
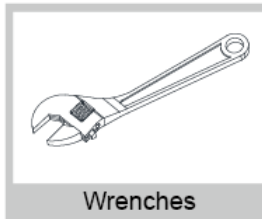
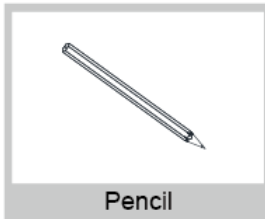
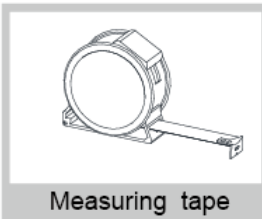

INSTALLATION TIPS

- For optimum installation results homeowner, cabinet maker, countertop and sink installers should all be involved in the planning and installation process.
- The manufacturer suggests this sink be installed by a locally licensed professional and recommends using the actual sink to determine the final cabinet and countertop dimensions.
- Prior to installation be sure to inspect sink for damage. The manufacturer is not responsible for damage caused during installation or by improper installation.
- Be sure to use proper tools and always wear personal protective equipment for your safety.
- Caution: Metal edges may be sharp – handle with care.

LUXART® Undermount Stainless Steel Sinks

Installation / Installation / Instalación

Undermount sinks are sinks that are attached from below the countertop. These instructions are for installing L X Brand undermount stainless steel sinks in a solid surface countertop only. Minimum thickness of the actual countertop material is one half-inch. In addition, a one-inch build up around the sink is preferred. The manufacturer recommends that undermount sinks and routing of your solid surface material should be installed by a professional installer for best results. Requirements vary for installation in a granite, marble, stone, or butcher block countertop.

There are three ways an undermount sink can be installed; Positive Reveal, Flush, or Negative Reveal. Each different reveal creates a distinctive look where the countertop and sink meet (see diagram below).

Positive Reveal - The countertop edge sits approximately 1/4" back from the edge of the sink, exposing the sink rim. All L X brand undermount sinks feature a 1 inch finished rim. All L X brand undermount sinks feature an approximate 1/4" positive reveal.

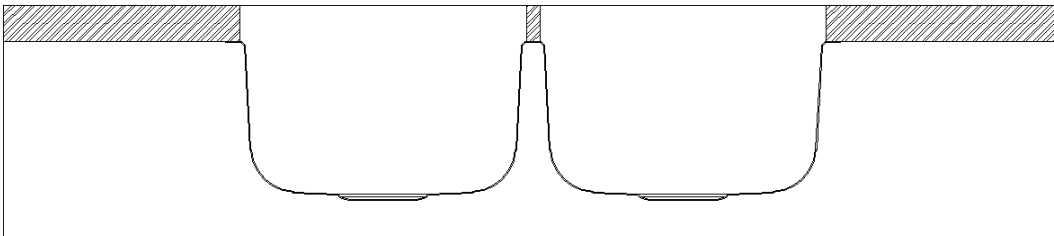

Flush - The countertop meets the edge of the sink. Fitting flush with the sink bowls

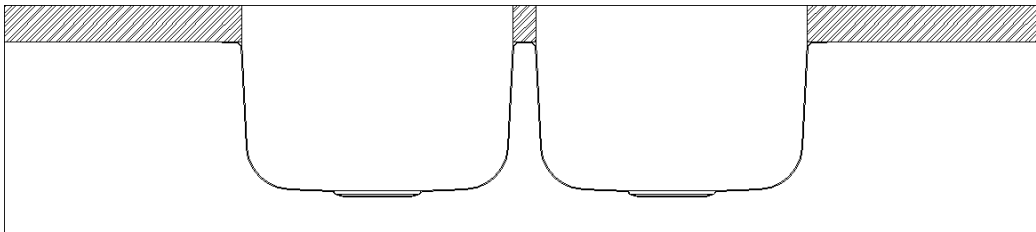

Negative Reveal - The counter top extends over the edge of the sink on all sides by approximately 1/4". Use caution with this installation to be sure that accessories such as colanders or cutting boards will fit properly.

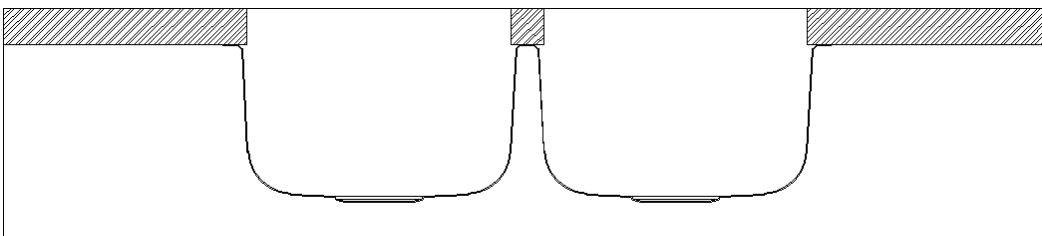

MLUX Brands recommends that all countertops be cut by an approved or certified installer and that the sinks be installed by the installer whenever possible. The countertop/sink unit ideally should be installed as one on the jobsite. Please carefully read all instructions before beginning installation.

Installation / Installation / Instalación

Step 1 – Preparing the countertop

Place the template (B) on the countertop. Ensure the template is centered on the counter so that it is parallel to the counter edge and that the installation hole will not interfere with the structure of the cabinet.

Tape the template (B) to the countertop to keep it in place and trace the cutout line on the template (B) with a pencil.

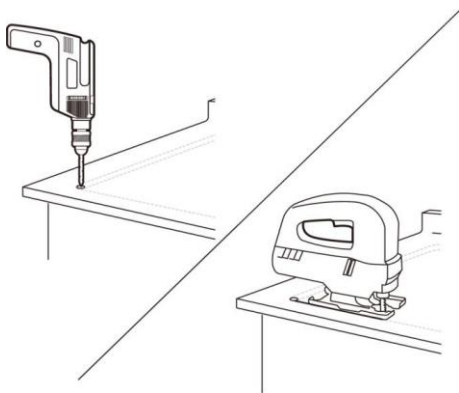
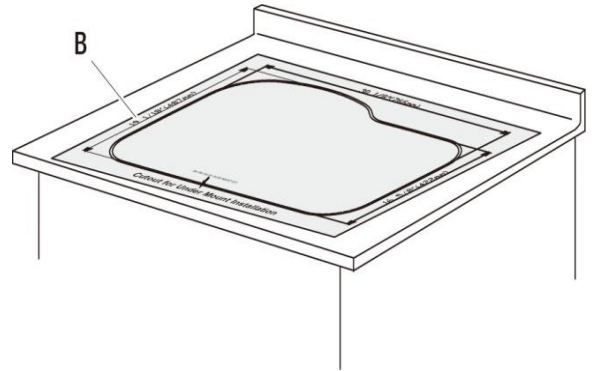

Step 2 – Cutting the installation hole

Drill a pilot hole and cut the countertop opening. Use the appropriate cutting tool for the surface you are cutting and cut along the inside of the template line.

Step 3 – Drilling holes for the clips

On the underside of the counter, mark the location of the twelve holes for the clips. These holes should be equally spaced around the perimeter of the cutout.

Using an electric drill with a 11 mm drill bit, drill each hole so that it is 11 mm in diameter and 14 mm deep.

Insert the plastic caps from each of the clips into each of the installation holes.

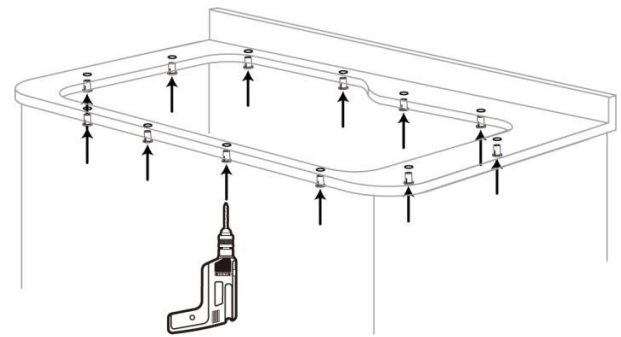

Step 4 – Installing the sink

Insert the screws (1) loosely in the holes that you drilled in the underside of the counter. Ensure that you use the clips in the locations that have the narrowest clearance between the sink and counter.

Place a small bead of silicone sealant (not included) around the upper lip of the sink (A).

Carefully place the sink (A) into its location under the counter, with the lip of the sink being supported by the clips (AA).

Tighten the screws (1) evenly, ensuring the sink (A) remains in place. Wipe away any excess silicone and, for best results, allow the bond to rest undisturbed for 8 hours or overnight.

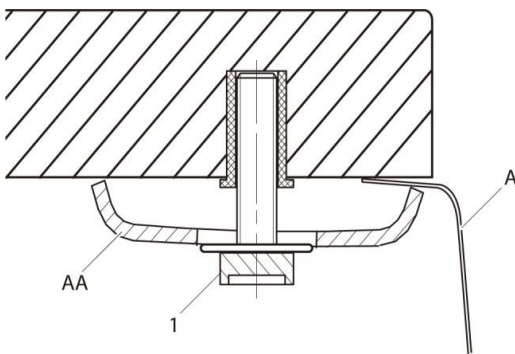

Installation / Installation / Instalación

Care & Cleaning Guidelines

Cleaning

- Daily, regular cleaning to remove dirt and prevent staining is recommended. Use liquid dish detergent, water and a soft household sponge.
- Mild, non-abrasive cleaners can be used with a nylon scrub pad. To ensure a uniform appearance in a stainless steel sink surface, rinse with water and wipe down the sink with a soft, dry cloth. Drying the sink will prevent water spots caused by time in the water.
- Remove stubborn stains from lime or calcium deposits by pouring a little warm vinegar or vinegar-based cleaner into the sink and allow it to sit for a few minutes. Rinse with clean water and dry.

Please note chlorides are found in most all soap, detergents, bleaches and cleansers. Chlorides can be harsh on stainless steel. Rinse your sink thoroughly after each use to remove any chloride residue.

Scratches

Scratches are inevitable during your usage over time. To treat, use a nylon pad with an iron free abrasive polishing compound. Follow the original polish lines to blend out the scratch in a small area. Be cautious not to overdo the process, as cleaning too aggressively could result in a bright spot.

Rust Spots

Stainless steel does not rust. Rust stains are the result of iron particles introduced by water, cookware, and steel wool pads that react with water to create rust. Metal cleaners will remove rust spots.

Food Stains

Depending on the severity of the stain, use a bleach and water solution or pour the bleach onto a cloth and cover the stain. Allow the bleach to sit for at least 1/2 hour and then clean with dish detergent and water.

Some Don'ts

- DO NOT use strong abrasive cleaners, metal scrub pads, or steel wool. These will scratch the surface.
- DO NOT leave rubber mats or sponges inside the sink. Water trapped below could lead to stains.
- DO NOT let food with a high salt content sit inside the sink for prolonged periods of time.
- DO NOT allow chlorine bleach to sit inside a stainless steel sink for more than 1 hour.
- DO NOT allow drain cleaners to come into contact with the sink surface.
- DO NOT pour paint in your sink. The chemicals in acrylic paint will react with sinks if allowed to sit over 24 hours and will produce permanent marks. For latex based paints, remove any residue immediately using a paint remover manufactured by the same brand. Consult the paint remover recommendations before using on the sink. For all sinks, we also recommend nail polish remover, rubbing alcohol or an acetone based paint remover to eliminate paint residue.

LIMITED LIFETIME SINK WARRANTY

Luxart warrants to the original purchaser of Luxart Stainless Steel sinks installed in the United States or Canada for as long as the original purchaser owns his or her home that Luxart will provide an equivalent sink to replace any Luxart Stainless Steel sink that fails due to a manufacturing defect provided that the sink has been solely for residential use and has not been damaged due to abuse, misuse, or negligence. This limited warranty does not cover and Luxart is not liable for transportation costs, labor charges incurred and/or damages sustained during the course of installation, repair, or replacement of any product(s) provided under this limited warranty. This limited warranty is nontransferable.

To execute a warranty claim, the original purchaser must return to the place of purchase and validate that they are the original buyer of the sink by supplying the original sales receipt.

Luxart has the right to inspect any sink reported to be defective prior to replacement of the sink. All decisions are final. Replacement of the sink does not include removal of the defective sink, installation of the replacement sink, replacement of faucet, replacement of any parts, or any other related expense.

This warranty shall not apply in the event of:

- Improper installation or modification of a Luxart sink
- Damages resulting from abuse including dents resulting from impact of dropped objects
- Damages resulting from improper care or maintenance
- Normal use including scuffs or scratches
- Improper use (such as exposure to corrosive chemicals or cleaning compounds)
- Commercial use

Disclaimers. EXCEPT AS SET FORTH ABOVE, Luxart MAKES NO WARRANTIES, WHETHER EXPRESS, IMPLIED, OR STATUTORY REGARDING OR RELATING TO THE PRODUCT OR SERVICE SUPPLIED HEREUNDER. THE PRODUCT MANUAL, OR ANY MATERIALS OR SPECIFICATION PROVIDED BY Luxart, DOES NOT PROVIDE ANY WARRANTY WHATSOEVER. TO THE GREATEST EXTENT ALLOWED BY LAW, Luxart SPECIFICALLY DISCLAIMS ALL IMPLIED WARRANTIES OF MERCHANTABILITY AND FITNESS FOR A PARTICULAR PURPOSE (EVEN IF Luxart HAD BEEN INFORMED OF SUCH PURPOSE) WITH RESPECT TO THE PRODUCT.

Limitation on Damages. In no event shall the liability of Luxart exceed the purchase price of the sink. Luxart disclaims liability for any special, incidental, consequential, punitive or exemplary damages arising out of or in connection with the product, any other materials or services furnished hereunder, even if Luxart has been advised, knows, or should know of the possibility of such damages. The preceding constitutes Mainline's entire liability and your sole and exclusive remedy for breach of warranties herein set forth. (Some states do not allow the exclusion or limitation of implied limited warranties, so the above exclusion may not apply to you.) This warranty supersedes all other warranties, expressed or implied. The foregoing warranties are exclusive and made only to the original buyer.

Garantie Limitée à vie de L'évier

Luxart garantit à l'acheteur d'origine que les éviers en acier inoxydable de Luxart installés aux États-Unis ou au Canada tant que l'acheteur d'origine est propriétaire de son domicile seront remplacés par un évier en acier inoxydable Luxart en cas de défaut de fabrication, à condition que l'évier ne soit utilisé qu'à des fins résidentielles et n'ait pas été endommagé suite à un abus, une mauvaise utilisation ou une négligence. La garantie limitée ne couvre pas, et Luxart n'est pas responsable, des frais de transport, de main d'œuvre ou de tout autre dommage ayant lieu durant l'installation, la réparation ou le remplacement de tout produit fourni dans le cadre de cette garantie limitée. Cette garantie limitée n'est pas transférable.

Pour effectuer une réclamation dans le cadre de la garantie, l'acheteur d'origine doit revenir sur le lieu de l'achat et fournir la preuve d'achat d'origine en présentant la facture. Luxart se réserve le droit d'inspecter tout évier déclaré défectueux avant de le remplacer. Toutes les décisions sont finales. Le remplacement de l'évier n'inclut pas le retrait de l'évier défectueux, ni l'installation de l'évier de rechange, le remplacement du robinet ou de toute autre pièce, ni aucun frais associé.

Cette garantie ne s'applique pas dans les cas suivants :

- Installation incorrecte ou modification de l'évier Luxart
- Dommages résultant d'un abus, y compris traces de chocs dues à des impacts ou des chutes d'objets
- Dommages résultant d'un soin ou d'un entretien inadéquats
- Usure normale incluant abrasions ou rayures
- Utilisation incorrecte (telle qu'exposition à des produits chimiques ou des agents de nettoyage corrosifs)
- Utilisation commerciale

Avis de non-responsabilité. EXCEPTÉ TEL QU'INDIQUÉ CI-DESSUS, Luxart N'OFFRE AUCUNE GARANTIE, EXPRESSE, IMPLICITE OU LÉGALE, RELATIVE AU PRODUIT OU AU SERVICE FOURNIS AUX TERMES DES PRÉSENTES. LE MANUEL DU PRODUIT, NI TOUT AUTRE MATÉRIEL OU SPÉCIFICATION FOURNIS PAR Luxart, NE FOURNISSENT DE GARANTIE QUELCONQUE. DANS TOUTE LA MESURE ACCORDÉE PAR LA LOI, Luxart REJETTE SPÉCIFIQUEMENT TOUTE GARANTIE DE QUALITÉ MARCHANDE OU D'ADAPTATION À UN USAGE PARTICULIER (MÊME SI Luxart A ÉTÉ INFORMÉ D'UN TEL OBJET) CONCERNANT LE PRODUIT.

Limitation concernant les dommages. La responsabilité de Luxart ne saurait en aucun cas dépasser le prix d'achat de l'évier. Luxart rejette toute responsabilité relative à des dommages spéciaux, indirects, consécutifs, punitifs ou exemplaires découlant ou relatifs au produit, à tout autre matériel ou service fournis aux termes des présentes, même si Luxart a été averti, connaît, ou devrait connaître la possibilité de tels dommages. Ce qui précède constitue l'intégrale responsabilité de Luxart et le seul et exclusif remède en cas de rupture des garanties présentées ici. (Certains États ne permettant pas l'exclusion ou la limitation de garanties limitées implicites, l'exclusion ci-dessus peut ne pas s'appliquer.) Cette garantie remplace toute autre garantie, expresse ou implicite. Ces présentes garanties sont exclusives et ne sont destinées qu'à l'acheteur d'origine.