







SPECIFICATIONS



Features

- Wall Bracket
- Finished Metal Body
- Mounting Hardware included

MLSWB

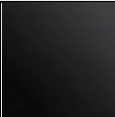
Standards & Certifications				Available Finishes			
							
	✓			✓			✓

Please visit [www.mainlinecollection.ca](http://www.mainlinecollection.ca) for available finishes. Finish is defined by additional suffix.

Drawings

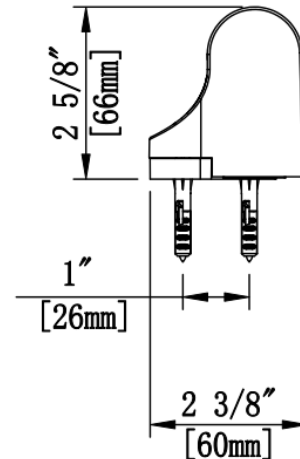
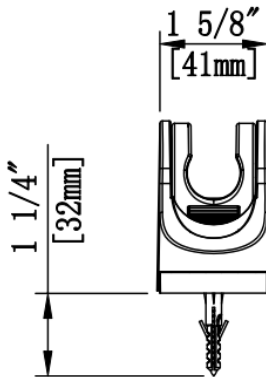

Specified model meets or exceeds the following:

- ASME A112.18.1/CSA B125.1
- IAPMO/cUPC

AVAILABLE MODELS

N/A

Mainline products have been manufactured under the highest standards of quality and workmanship. That is why we offer "Limited 5 Year" warranty on the function and finish of our accessories.



SUBMITTAL INFORMATION

Name: \_\_\_\_\_ Contractor: \_\_\_\_\_  
 Location: \_\_\_\_\_ Contact #: \_\_\_\_\_  
 Notes: \_\_\_\_\_

Service & Parts

Please reach out to [epleservice@emcoltd.com](mailto:epleservice@emcoltd.com) for support/ visit [mainlinecollection.ca](http://mainlinecollection.ca) / CANADA +1 (450) 621 5636