

Installation / Installation



Paper Holder

Porte-rouleau papier toilette

Tools You Will Need / Outils dont vous aurez besoin



Drill
Perceuse

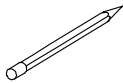

Pencil
Crayon

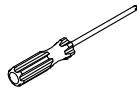

Phillips Screwdriver
Tournevis cruciforme



Hex Wrench
Clé hexagonale

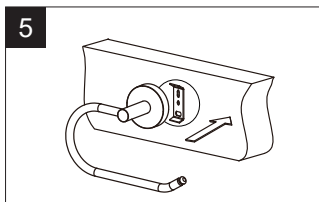
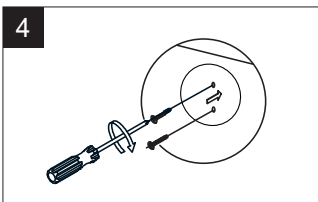
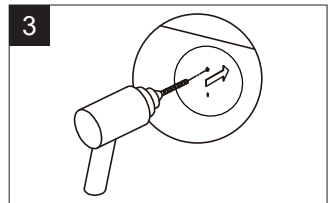
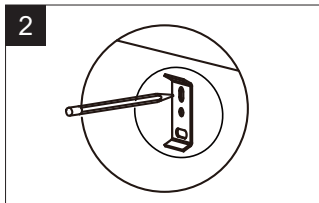
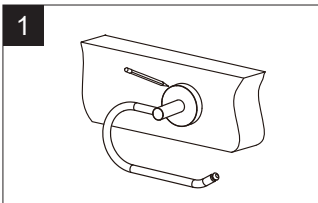

Installation / Installation

Replacement Parts / Pièces de rechange

No.	Description	Part No.
1	Plastic Anchors, Mounting bracket & Wood Screws / Chevilles de plastique, support de fixation & vis à bois	642014
2	Set Screw & Hex Wrench / Vis à pression & Clé hexagonale	642050

** please indicate finish for these parts*

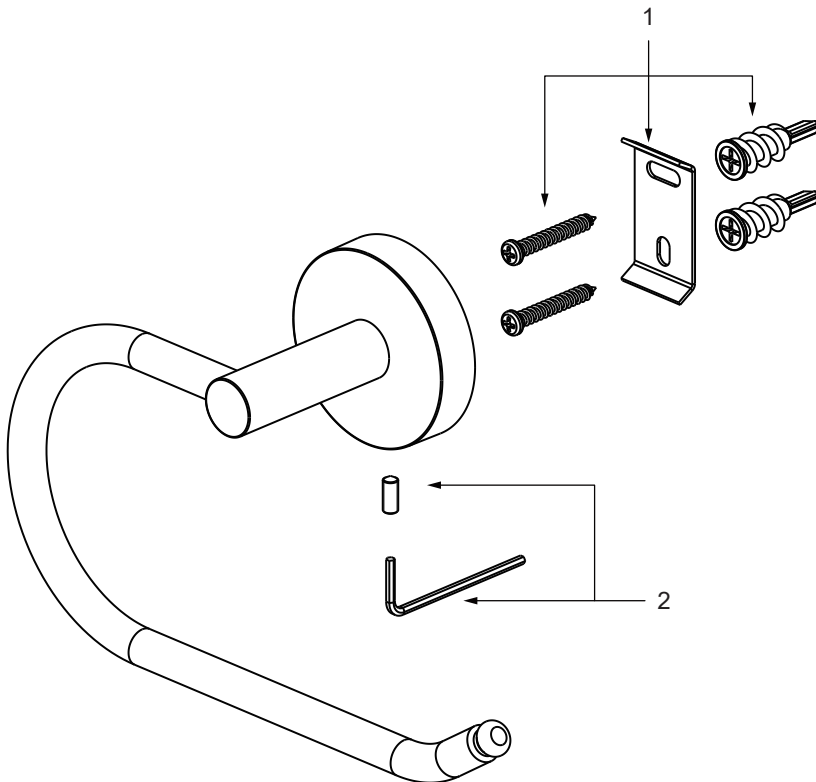

Need help? Please call our customer service line at +1(450) 621-5636 for additional assistance or service. See product label for more information to visit our website: mainlinecollection.ca

Besoin d'aide? Veuillez communiquer avec notre service à la clientèle au +1(450) 621-5636 pour tous renseignements ou services complémentaires. Voir l'étiquette du produit pour plus d'informations pour visiter notre site web: mainlinecollection.ca

