







SPECIFICATIONS



MLMSD

Features

- Hybrid Construction.
- Finished Body
- Max Capacity 300 ML.

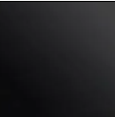
Standards & Certifications				Available Finishes			
							
	✓			✓	✓	✓	✓

Specified model meets or exceeds the following:

- ASME A112.18.1/CSA B125.1
- IAPMO/cUPC

AVAILABLE MODELS

N/A

Mainline products have been manufactured under the highest standards of quality and workmanship. That is why we offer "Limited 5 Year" warranty on the function and finish of our accessories.



Please visit www.mainlinecollection.ca for available finishes. Finish is defined by additional suffix.

Drawings

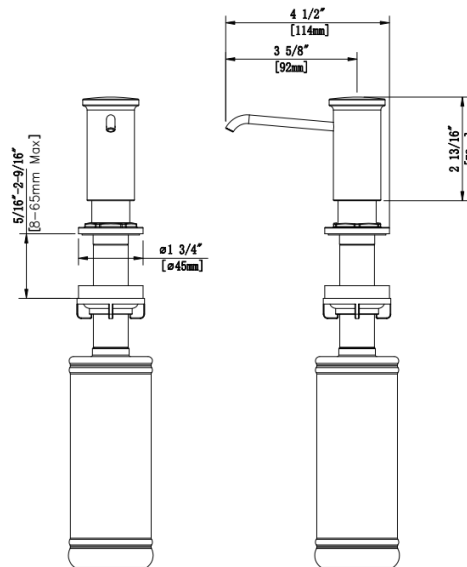

SUBMITTAL INFORMATION

Name: _____ Contractor: _____

Location: _____ Contact #: _____

Notes: _____

Service & Parts

Please reach out to epleservice@emcoltd.com for support/ visit mainlinecollection.ca / CANADA +1 (450) 621 5636