





SPECIFICATIONS







BL511

Features

- Includes Ceramic Disc Cartridge
- Requires Mainline M410 Rough-in Valve
- Easy – Press to Place Installation
- Deep Installation Adapters (Optional)
- ADA

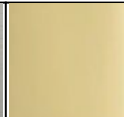
Standards & Certifications			
			
	✓		✓

Available Finishes			
			
✓		✓	✓

Please visit www.mainlinecollection.ca for available finishes. Finish is defined by additional suffix.

Drawings – Valve Trim

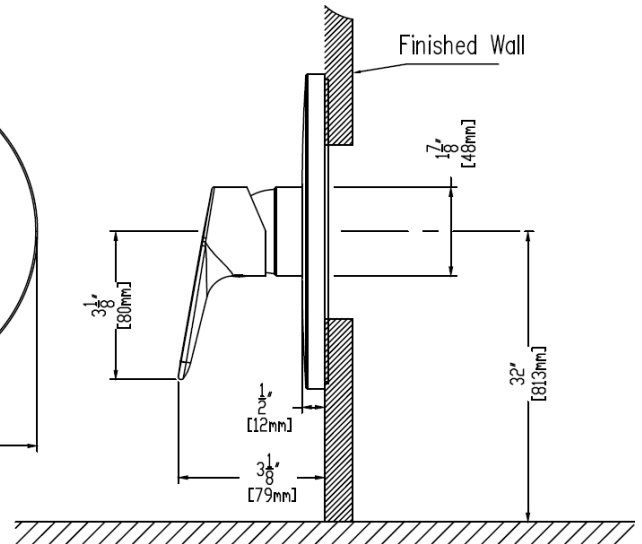
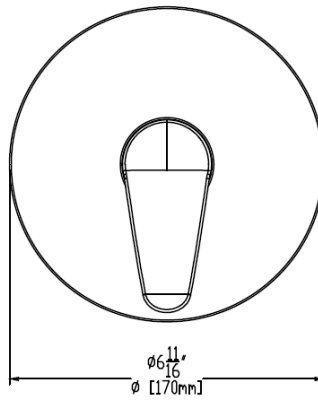

Specified model meets or exceeds the following:

- ASME A112.18.1/CSA B125.1
- IAPMO/cUPC
- ADA for lever handle control

AVAILABLE FORMATS

Shower Only – Multiple Models
Tub & Shower – Multiple Models

Mainline products have been manufactured under the highest standards of quality and workmanship. That is why we offer "Limited Lifetime" warranty on the function and finish of our faucets.



SUBMITTAL INFORMATION

Name: _____ Contractor: _____

Location: _____ Contact #: _____

Notes: _____

Service & Parts

Please reach out to epleservice@emcoltd.com for support/ visit mainlinecollection.ca / CANADA +1 (450) 621 5636