

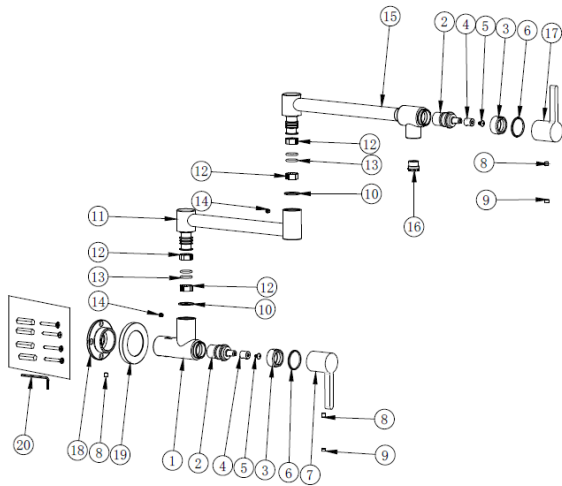

Spare Parts



No	Description	Part Number
1	Body	PM138SS-01
2	Cartridge	PM138SS-02
3	Bonnet	PM138SS-03
4	Retainer	PM138SS-04
5	Screw	PM138SS-05
6	O-Ring	PM138SS-06
7	Handle	PM138SS-07
8	Screw	PM138SS-08
9	Cover Plug	PM138SS-09
10	O-Ring	PM138SS-10
11	Pivot Shank	PM138SS-11
12	Retainer	PM138SS-12
13	O-Ring	PM138SS-13
14	Screw	PM138SS-14
15	Spout	PM138SS-15
16	Aerator	PM138SS-16
17	Handle	PM138SS-17
18	Base	PM138SS-18
19	Cap	PM138SS-19
20	Mounting Hardware	PM138SS-20

Warranty

Faucet Function and Finish Lifetime Limited Warranty

MLUX warrants to the original consumer purchaser for as long as the original consumer purchaser owns their home ("the warranty period" for homeowners) that this product will be free from defects in materials and manufacturing workmanship. MLUX recommends using a professional plumber for all installation and repair. MLUX will provide, free of charge, at its sole option, replacement part(s) or product, (or if no longer available, a comparable product), to replace, or make appropriate adjustment for, those which have proven defective in materials or workmanship under normal installation, use and service. This limited warranty does not cover, and MLUX is not liable for, labor charges incurred and/or damages sustained during the installation, repair or replacement of any part(s) or product(s) provided under this limited warranty. In no event shall the liability of MLUX exceed the purchase price of the faucet. This limited warranty is nontransferable. Proof of purchase (original sales receipt) from the original consumer purchaser must be made available to MLUX for all limited warranty claims. This warranty does not apply in the event of product damage due to the use of other than genuine MLUX replacement parts, installation error, abuse, misuse, or improper care and maintenance, (whether performed by a plumber, contractor, service provider, or member or purchaser's household). This limited warranty excludes damage due to aggressive air or water conditions, or harsh or abrasive cleaners and/or materials*. This limited warranty is applicable only to MLUX faucets installed in the United States and Canada.

THIS IS THE EXCLUSIVE WARRANTY BY MAINLINE, WHICH IS IN LIEU OF ALL OTHER WARRANTIES, EXPRESS OR IMPLIED, INCLUDING BUT NOT LIMITED TO THE IMPLIED WARRANTIES OF MERCHANTABILITY AND FITNESS FOR A PARTICULAR PURPOSE.

This warranty gives you specific legal rights, and you may also have other rights which vary from state/province to state/province. Some states/provinces do not allow the exclusion or limitation of incidental or consequential damages, so the above limitation or exclusion may not apply to you. SELLER DISCLAIMS ANY LIABILITY FOR SPECIAL, INCIDENTAL, CONSEQUENTIAL, PUNITIVE OR EXEMPLARY DAMAGES. Some states/provinces do not allow limitations on how long an implied warranty lasts or the exclusion or limitation of such damages, so these limitations and exclusions may not apply to you. This warranty gives the consumer specific legal rights. You may also have other rights that vary from state/province to state/province. This limited warranty EXCLUDES all industrial, commercial and business usage, whose purchasers are hereby, extended a five-year limited warranty applying to all other terms of this limited warranty except duration. *Never use cleaners containing abrasive cleansers, ammonia, bleach, acids, waxes, alcohol, solvents, or other products not recommended for chrome. This will void the warranty.

Contact us: Have Questions or in need of support?

Visit our website. See Product Label for more information.



Installation Instructions

MODEL : PM138SS
Wall Mount Kitchen Pot Filler
Faucet Installation



Tools You will Need



Adjustable Wrench



Pipe Tape



Phillips Screwdriver



Drill

Installation Tips

- The manufacturer suggests using a locally licensed plumber for installation.
- Cover your drain to avoid losing parts.

Troubleshooting

If you have followed the instructions and your faucet is still not working properly, use this.

Problem	Cause	Action
Leak underneath the handle.	Retainer nut has come loose. O-ring is dirty or damaged.	Tighten the retainer nut. Clean or replace the O-ring.
Aerator leaks or has inconsistent water flow pattern.	Aerator is dirty or misfitted.	Unscrew aerator, remove any debris, check seating of rubber seal and then re-assemble the aerator.



Installation Instructions

Please check the accessories very carefully after you open the box, if it's not accordance to the drawing, please contact us. Note : Sketch drawing is only for reference.

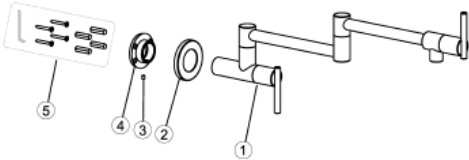

No.	Parts & Accessories	QTY
1	Faucet Body	1
2	Cap	1
3	Set Screw	1
4	Mounting Retainer Kit	1
5	Mounting Accessories	1

1. Do not disassemble the main body, as it has been installed & commissioned correctly & precisely before leaving the factory;
2. To avoid the faucet from jamming, do flush the water pipe before installation;
3. After installation, make sure every joint safely sealed & no leakage;
4. Using condition: Working pressure at 0.05-1.0MPa (including cold & hot water pressure) with applicable water temperature: 4-90 °C;
5. Make sure to connect the hot/cold inlet pipe correctly, if standing in front, hot water pipe connecting to the left & cold-water pipe connecting to the right.

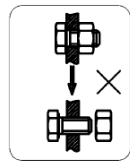

Do not disassemble

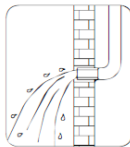

Flush the Pipe

Please pay attention to the size on the drawing when you assemble:
Please assemble according to the drawing, pressurize the tie-ins with tape.

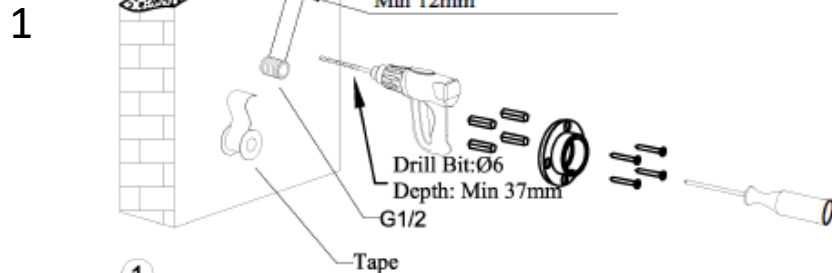

Installation Instructions

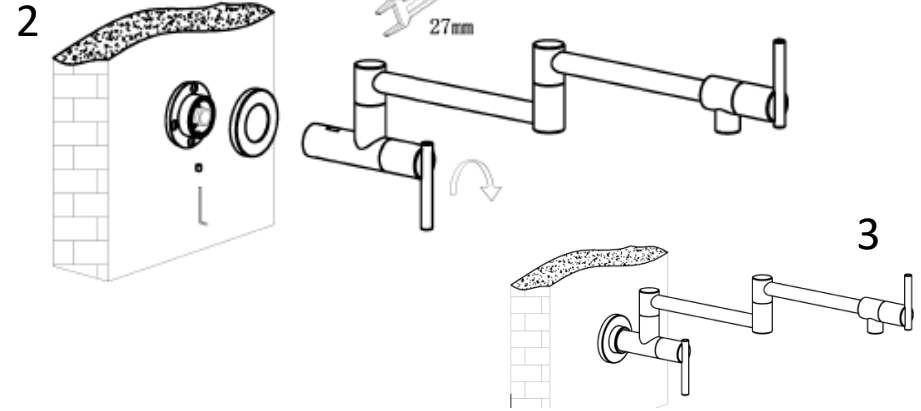

OPERATION METHOD

How to operate the handle:

- A) Handle lever up clockwise to open, anticlockwise to close water flow.
- B) Turn the handle lever to the left to increase water flow and decrease by operating reversely.

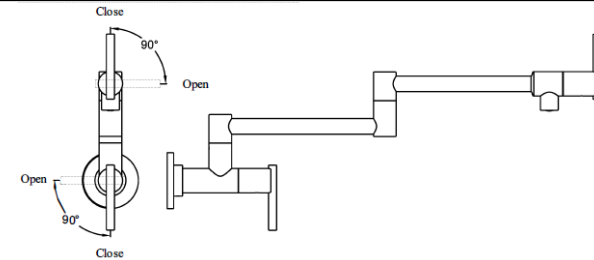

CLEANING & MAINTENANCE

To keep the product clean & shining, follow the steps as below:

1. Flush with clean water & dry with soft cloth only;
2. If any dirt, clean with soft liquid or transparent glass detergent;
3. Do not use any scrubbing detergent, polisher, sand-cloth, paper tissue or scrape;
4. Do not use acid detergent, insoluble grain-like detergent or soap;
5. During using, the aerator may accumulate the mud, which makes the water flow slow. So circumrotate the aerator off and clean it when necessary.

