



# **INSTALLATION & OPERATION MANUAL**

## **SUBMERSIBLE SUMP PUMPS**

**Models:**

**MLP72260, MLP72372**

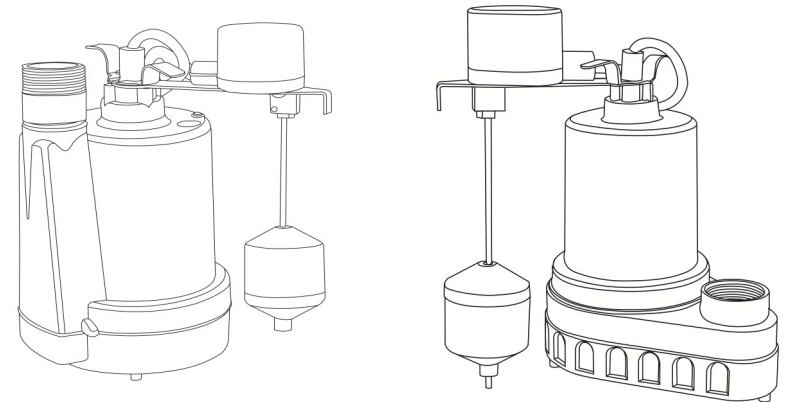



## Safety Guidelines

Carefully read, understand and follow all safety instructions in this manual.

 This is the safety alert symbol. When you see this symbol, look for one of the following signal words.

 **DANGER** Indicates a hazardous situation which, if not avoided, will result in death or serious injury.

 **CAUTION** Indicates a hazardous situation which, if not avoided, could result in death or serious injury.

 **WARNING** Indicates a hazardous situation which, if not avoided, could result in minor or moderate injury.

## Safety Information

Read these warnings carefully. Know the application and limitations of this pump. Failure to follow these warnings could result in serious bodily injury and/or property damage.

 **DANGER** RISK OF ELECTRICAL SHOCK. Disconnect and lockout power supply before removing old pump or installing or servicing this pump.

 **DANGER** RISK OF ELECTRICAL SHOCK. This pump is supplied with a grounding conductor and grounding type attachment plug. To reduce the risk of electric shock, be certain that it is connected only to a properly grounded, grounding type receptacle. For added safety, it is highly recommended to connect this pump to a GFCI (Ground Fault Circuit Interrupter) outlet. Connect only to a receptacle that is adequately rated for the voltage and amperage of this pump.

 **WARNING** The installation of this pump must be in accordance with the National Electric Code (NEC), Uniform Plumbing Code (UPC), International Plumbing Code (IPC) as well as all applicable local codes and ordinances.

 **CAUTION** Do not install this pump in any location classified as hazardous by the National Electrical Code, ANSI/NFPA70.

 **CAUTION** Do not use this pump to pump flammable or explosive fluids such as gasoline, kerosene, etc. Do not use this pump in flammable or explosive environments. Use only with liquids compatible with pump component materials.

 **WARNING** RISK OF ELECTRICAL SHOCK. This pump has not been investigated for use in swimming pool or marine areas.

 **WARNING** RISK OF ELECTRICAL SHOCK. **DO NOT** use the power cord to remove or lower the pump into the basin. The cord may pull apart exposing bare wires which could cause a fire or electrical shock. Use the handle supplied with the pump for installing and removing the pump from the basin.

 **WARNING** Do not run the pump dry. This pump relies on water for cooling. Running the pump dry can cause the pump to overheat and the possibility of burns to anyone that handles the pump. Running the pump dry will void the warranty.

 **WARNING** Don't expose pump to freezing temperatures. Discharge lines exposed to freezing temperatures should be positioned with a downward slope to prevent freezing.

## LIMITED WARRANTY - SUMP PUMPS:

Manufacturer warrants the products specified in this warranty to be free from defects in material or workmanship for three (3) years from date of purchase. During the time period and subject to the terms and conditions, the manufacturer will repair or replace to the original user or consumer any portion of this product which proves to be defective due to materials or workmanship. At all times the manufacturer shall have and possess the sole right and option to determine whether to repair or replace defective equipment, parts, or components. The manufacturer has the option to inspect any product returned under warranty to confirm that the warranty applies before repair or replacement under warranty is approved. This warranty sets forth the manufacturer's sole obligation and purchaser's exclusive remedy for defective product. Return defective product to the place of purchase for warranty consideration.

## WARRANTY PERIOD - PRODUCTS:

If, within the duration of product use by the original user, this product proves to be defective due to materials or workmanship, the product shall be repaired or replaced at the manufacturer's option, subject to the terms and conditions set forth in this warranty statement. Proof of purchase is required for warranty consideration. In the absence of suitable proof of the purchase date, the effective period of this warranty is 12 months from the product's date of manufacture.

## LABOR, ETC. COSTS:

The manufacturer shall IN NO EVENT be responsible or liable for the cost of field labor or other charges incurred by any customer in removing and/or affixing any product, part, or component thereof.

## PRODUCT IMPROVEMENTS:

The manufacturer reserves the right to change or improve its products or any portions thereof without being obligated to provide such a change or improvement for units sold and/or shipped prior to such change or improvement.

## GENERAL TERMS AND CONDITIONS:

This warranty shall not apply to damage due to acts of God, normal wear and tear, normal maintenance services and the parts used in connection with such service, lightning or conditions beyond the control of the manufacturer, nor shall it apply to products which, in the sole judgment of the manufacturer, have been subject to negligence, abuse, accident, misapplication, tampering, alteration; nor due to improper installation, operation, maintenance or storage; nor to excess of recommended maximums as set forth in the instructions. Warranty will be VOID if any of the following conditions are found:

1. Product is used for purposes other than those for which it was designed and manufactured
2. Product not installed in accordance with applicable codes, ordinances, and good trade practices
3. Product connected to voltage other than indicated on nameplate or labels
4. Pump exposed to but not limited to the following: sand, gravel, cement, grease, plaster, mud, tar, oil, gasoline, solvents or other abrasive or corrosive substances
5. Pump has been used for pumping liquids above 120°F
6. Pump allowed to operate dry (liquid supply cut off)

## DISCLAIMER:

Any oral statements about the product made by the seller, the manufacturer, the representatives, or any other parties do not constitute warranties, shall not be relied upon by the user, and are not part of the contract for sale. Seller's and the manufacturer's only obligation, and buyer's only remedy, shall be the replacement and/or repair by the manufacturer of the product as described above. NEITHER SELLER NOR THE MANUFACTURER SHALL BE LIABLE FOR ANY INJURY, LOSS OR DAMAGE, DIRECT, INCIDENTAL OR CONSEQUENTIAL (INCLUDING, BUT NOT LIMITED TO, INCIDENTAL OR CONSEQUENTIAL DAMAGES FOR LOST PROFITS, LOST SALES, INJURY TO PERSON OR PROPERTY, OR ANY OTHER INCIDENTAL OR CONSEQUENTIAL LOSS), ARISING OUT OF THE USE OR THE INABILITY TO USE THE PRODUCT, AND THE USER AGREES THAT NO OTHER REMEDY SHALL BE AVAILABLE TO IT. Before using, the user shall determine the suitability of the product for his/her intended use, and user assumes all risk and liability whatsoever in connection therewith.

THE WARRANTY AND REMEDY DESCRIBED IN THIS LIMITED WARRANTY IS AN EXCLUSIVE WARRANTY AND REMEDY AND IS IN LIEU OF ANY OTHER WARRANTY OR REMEDY, EXPRESSED OR IMPLIED, WHICH OTHER WARRANTIES AND REMEDIES ARE HEREBY EXPRESSLY EXCLUDED, INCLUDING BUT NOT LIMITED TO ANY IMPLIED WARRANTY OF MERCHANTABILITY OR FITNESS FOR A PARTICULAR PURPOSE, TO THE EXTENT EITHER APPLIES TO A PRODUCT SHALL BE LIMITED IN DURATION TO THE PERIODS OF THE EXPRESSED WARRANTIES GIVEN ABOVE.

Some states and countries do not allow the exclusion or limitations on how long an implied warranty lasts or the exclusion or limitation of incidental or consequential damages, so the above exclusion or limitations may not apply to you. This warranty gives you specific legal rights, and you may also have other rights which vary from state to state.



## Description

This Sump pump is designed to remove ground water from residential sump pits. The motor is oil cooled and hermetically sealed. A float switch is provided for automatic operation and is equipped with a 10', 3 prong grounding type power cord.

## Specifications

Model	MLP72260	MLP72372
HP	1/4	1/3
Volts	120 volt AC	120 volt AC
Amps	3.8 Amps	4.1 Amps
Hz	60 Hz	60 Hz
Phase	1	1
Discharge Size	1-1/4" NPT or 1-1/2" MPT with included adapter	1-1/2" FNPT
Max. Solids Handling	1/8"	3/8"
Liquid Temperature Range	32°F - 120°F	32°F - 120°F
Cord Length	10'	10'
Switch Type	Vertical	Vertical
Switch on Level (Factory Set)	6"	6.5"
Switch off Level (Factory Set)	2"	2"
Pump Housing Construction	Thermoplastic	Thermoplastic
Pump Base Construction	Thermoplastic	Thermoplastic
Impeller	Thermoplastic	Thermoplastic
Motor Shaft	Stainless Steel	Stainless Steel
Shaft Seal	Carbon/Ceramic/ Stainless Steel	Carbon/Ceramic/ Stainless Steel
Fasteners	Stainless Steel	Stainless Steel
Shut off head	26'	26'
Max. PSI	10.8	10.8

## Replacement Parts

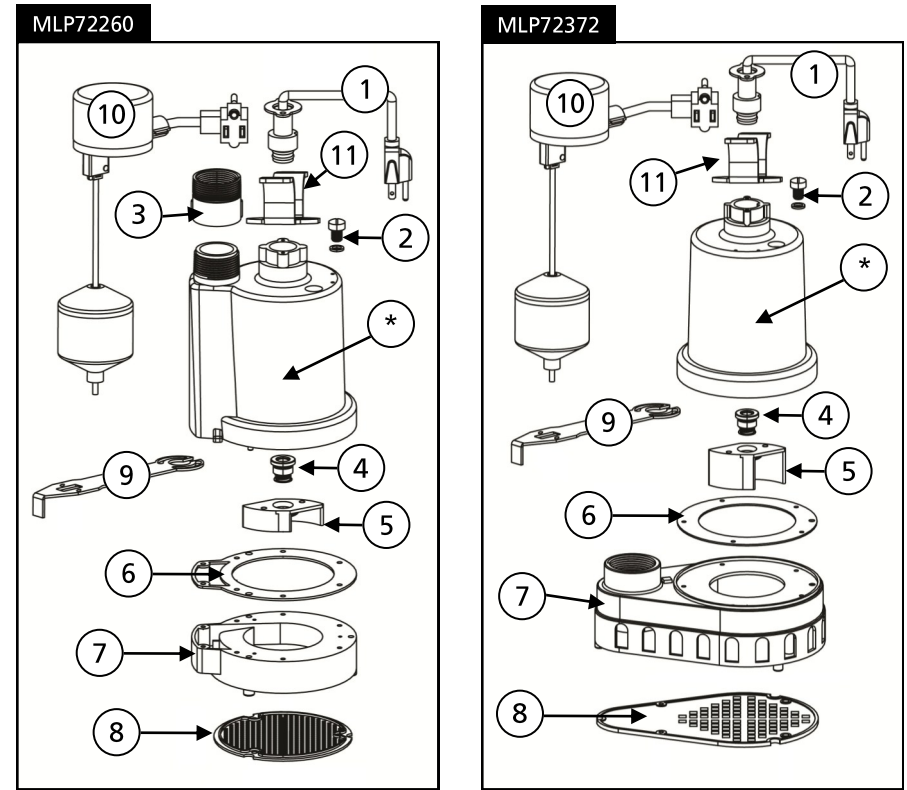

Ref#	Description	MLP72260	MLP72372
1	Power Cord	99008	99008
2	Oil Fill Plug with O-ring	99056	99056
3	Coupling/Adapter	99007	n/a
4	Shaft Seal	99057	99057
5	Impeller	99060	99065
6	Gasket	99062	99187
7	Volute/Base	99067	99185
8	Intake Screen	99073	99186
9	Vertical Float Switch Bracket	99105	99105
10	Vertical Float Switch (includes switch, float rod, float ball and grommet)	92010	92010
11	Handle	99051	99051

\*If motor fails, replace entire pump

## Performances

Height and/or piping restriction will reduce the pump output performance. It is recommended to use the same size or larger pipe as the pump discharge for optimum performance.

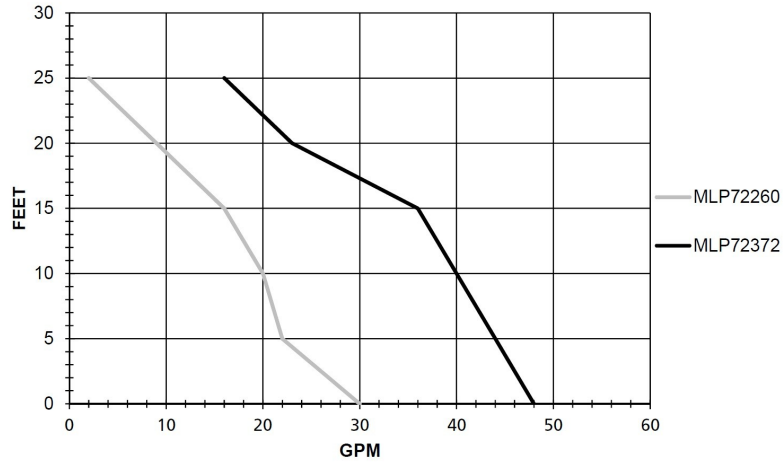

Model	Discharge Height	0'	5'	10'	15'	20'	25'
MLP72260	Gallons Per Minute	30	22	20	16	9	2
MLP72372	Gallons Per Minute	48	44	40	36	23	16

## Installation

### Removing old pump (if necessary)

1. Remove the old pump from the basin. If you need to cut the old discharge pipe to remove the pump, cut it as close to floor level as possible. If a check valve is attached to the pump, be prepared for water to leak from the pipe. Allow water to drain into the sump basin.
2. Inspect the basin for accumulated mud, sand, silt or small stones. Clean out the basin if necessary.

### Install new pump

1. Connect the discharge pipe to the pump discharge. Do not use pipe joint compound on plastic pipe or plastic pump threads as this can degrade the plastic. Use Teflon<sup>®</sup> tape if necessary.
2. Install a full flow, swing type check valve (sold separately) either directly into the pump discharge or on the discharge pipe. Make sure the check valve is positioned in the correct direction of flow.
3. Place the pump on a solid, level surface in the basin. Use bricks or blocks to raise the pump off the bottom surface. Do not place the pump directly in mud, sand, silt or on rocky surfaces as these materials can clog or cause damage the pump. Do not lower the pump into the basin by the power cord or discharge pipe, use the attached handle.
4. Position the pump in the basin making sure that the float switch will operate freely without coming in contact with the sides of the basin.
5. Once the pump is positioned in the basin, mark and cut your existing discharge pipe to fit the height of the pump or continue installation of new discharge pipe to the outside of the building.

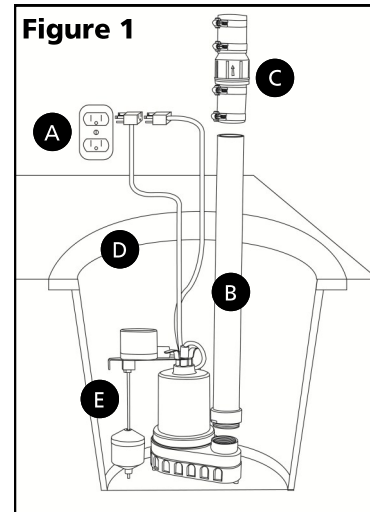
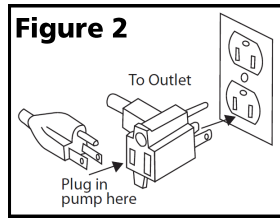

**Figure 1**

- A. Grounded Outlet. A GFCI outlet is strongly recommended.
- B. Discharge Pipe
- C. Full-flow swing type check valve
- D. Sump Basin
- E. Position pump so the float switch operates freely without touching the sides of the basin.

## Operation

1. Plug the piggy-back plug of the float switch into a 120 volt grounded outlet. The use of a GFCI is strongly recommended. Plug the pump plug into the back of the float switch plug. See Figure 2.
2. Test your installation by filling the basin with water. Observe the float switch through at least one complete cycle to ensure it operates freely and does not contact the sides of the basin. If necessary, adjust the float switch or reposition the pump to ensure proper operation.
3. This pump is equipped with an anti-airlock hole. A stream of water will emit from this hole when the pump is operating. This is a normal feature of this pump. The anti-airlock hole should be cleaned periodically to prevent the pump from becoming air locked.
4. Do not let the pump run dry. The pump depends on water for cooling and lubrication. Operating the pump without water may cause the motor to overheat or cause damage to internal parts. It may also shorten the life of your pump.
5. Your pump motor is thermally protected. It is not recommended for pumping liquids over 120° F (49° C). The thermal overload protector will automatically shut down the pump in an overheat situation. The pump will reset itself once the pump cools down. This overload is designed as a safety device and it will fail after repeated use. Normal operation is for fluids between 32° F & 120° F (0° C - 49° C).



## Maintenance

**⚠ DANGER** Risk of electric shock. Always disconnect the power supply before attempting to install, service or perform maintenance on the pump.

**⚠ WARNING** All repairs must be made by an authorized service center.

**⚠ CAUTION** This submersible pump contains oil which may become pressurized and hot under normal operating conditions - allow the pump to cool for 2-3 hours before servicing.

1. The pump motor is hermetically sealed in the housing and does not require any service. Disassembly of the motor housing or modification of the power cord voids the warranty.
2. Periodically check the sump basin for accumulation of mud, silt, sand and foreign objects. Clean the basin as needed to prevent damage or clogging of the pump.
3. Periodically check the removable intake screen for obstructions. Clean if necessary.
4. Periodically inspect and clean the anti-airlock hole.
5. Inspect the float switch for any accumulated debris that may inhibit it from operating properly. Clean if necessary.
6. Inspect the impeller for signs of wear and obstructions.
7. Inspect the power cord for signs of damage or wear. Do not operate the pump if the cord is damaged or worn.
8. In applications where the pump may not activate for extended periods of time, it is recommended to cycle the pump at least once per month to ensure the pumping system is working properly when needed.

## Troubleshooting

Problem	Possible Causes	How to Correct
If the pump does not start or run	Pump is not plugged in, switch or breaker is turned off	Plug pump in or turn on switch/breaker
	Check for blown fuses or tripped circuit breakers or tripped GFCI outlets	Replace fuse, reset breaker, reset GFCI outlet
	Float switch is defective	Check and replace if necessary
	Motor thermal protector tripped	Allow pump to cool. Pump will reset automatically
	Float switch is stuck or obstructed	Remove obstruction or position pump so the float switch will operate freely
The pump starts and stops too often	Backflow of water from discharge hose/pipe	Install or replace check valve
	Float switch is defective	Replace float switch
If the pump runs but moves little or no water	Clogged discharge hose/pipe	Remove clog
	Frozen discharge hose/pipe	Allow hose/pipe to thaw
	Pump is air locked	Check airlock hole for clogs and clean if necessary
	Low line voltage	Check wire size and increase if necessary
	Check valve is stuck in the closed position	Inspect, repair or replace if necessary
	Check valve is installed backwards	Make sure check valve is installed in the correct direction of flow
	Clogged intake screen	Clean or replace screen
	Worn, damaged or clogged pump parts	Inspect for wear, damage or clog and clean or replace part if necessary
Pump does not shut off	Discharge head exceeds pump capacity	See performance chart for pump limitations
	Float switch is obstructed or stuck	Remove obstruction
	Defective Float Switch	Replace float switch