

SPECIFICATIONS



Features

- Max Flow Rate : 1.2GPM(4.5L/Min) @ 60 PSI
- Fits 3 Hole
- Fits 4" Center Holes
- Polished Chrome
- ADA

Components





- Metal Lever Handle
- Finished Metal Body
- W/Brass Mechanical Pop-Up Drain
- Ball Valve Assembly
- Lead Free* Polymer Lined Waterways
- Water Saving Aerator

Drain Type

Brass Mechanical Pop-Up Drain (Included)

ES211-PUCP





Standards & Certifications

			
✓	✓	✓	✓

Available Finishes

			
✓			

Mount Type

			
	✓		

Specified model meets or exceeds the following:

- ASME A112.18.1/CSA B125.1
- IAPMO/cUPC
- NSF/ANSI 372
- NSF/ANSI/CAN 61 – Sec. 9: Q≤1
- ADA
- *≤ .25% Pb

AVAILABLE MODELS

ES211- CP – Lavatory Faucet

Mainline products have been manufactured under the highest standards of quality and workmanship. That is why we offer a "Limited 5 Year" warranty on the function and finish of our faucets.



Please visit www.mainlinecollection.ca for available finishes. Finish is defined by additional suffix.

Drawings

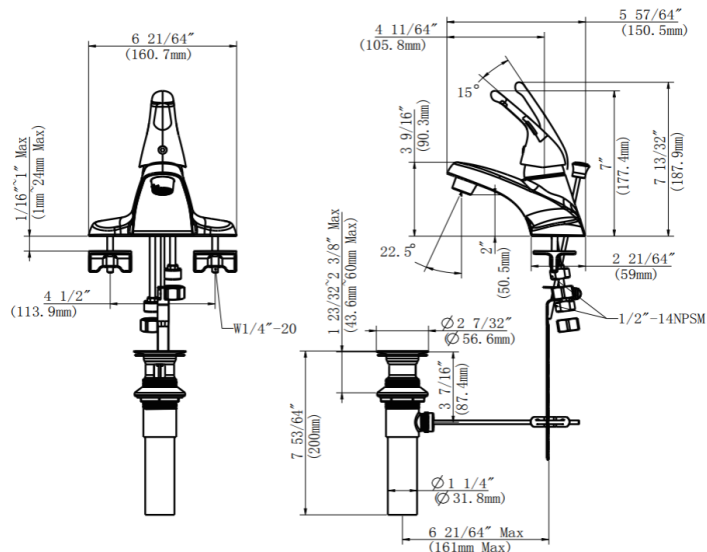

SUBMITTAL INFORMATION

Name: _____ Contractor: _____
 Location: _____ Contact #: _____
 Notes: _____

Service & Parts

Please reach out to epleservice@emcoltd.com for support/ visit mainlinecollection.ca / CANADA +1 (450) 621 5636